

# BAR CODE

PROGRAMMING MENU



# Contents

Chapter 1	Description	
1.1	Introduction .....	2
1.2	Codes Read .....	2
1.3	Installation .....	2
1.4	Pin Assignment .....	3
Chapter 2	Configuration-General	
2.1	Flow Chart .....	4
2.2	Loop of Programming .....	5
2.3	Factory Default Settings .....	5
2.4	Main Page of Configuration .....	6
2.5	Interface Selection .....	7
Chapter 3	Communication Parameters	
3.1	RS232 Mode Parameters .....	8
3.2	Keyboard Wedge Mode Parameters .....	10
3.3	Output Characters Parameters .....	12
Chapter 4	Barcode and Others	
4.1	Symbologies Selection .....	13
4.2	UPC/EAN/JAN Parameters .....	15
4.3	Code 39 Parameters .....	16
4.4	Code 128 Parameters .....	17
4.5	CODABAR/NW7 Parameters .....	18
4.6	Interleave 25 Parameters .....	19
Chapter 5	Miscellaneous Parameters	
5.1	Language Selection .....	20
5.2	Bar Code ID .....	21
5.3	Set Up Truncation .....	22
5.4	Set Up Preamble and Postamble .....	24
<b>Appendix</b>		
A.	ASCII Tables .....	26

# Chapter 1 Description

## 1.1 Introduction

The Decoder is an advanced and versatile decoding facility for barcoding systems. This manual provides an easy way to configure the decoding options and interface selections by scanning bar codes listed in the manual.

## 1.2 Codes Read

ALL UPC/EAN/JAN, Code 39, Code 39 Full ASCII, Code 128, Interleave 25, CODABAR/NW7

## 1.3 Installation

### Installing the Keyboard Wedge Reader

To install the keyboard wedge reader, follow the steps below:

1. Turn off the power of PC or Terminal.
2. Unplug keyboard from PC or Terminal.
3. Make sure you have Y Cable with appropriate connector type for your PC or Terminal.
4. Connect Decoder into your PC or Terminal and its keyboard.
5. Turn on the power of PC or Terminal.

### Installing the RS232 Reader

To install the RS232 reader, follow the steps below :

1. Turn off the power of PC or Terminal.
2. Make sure you have connector type for RS232, connect Decoder with your PC or Terminal.
3. Plug AC Adaptor or power cable into Decoder.
4. Turn on the power of PC or Terminal.

### Installing the USB Reader

To install the USB Reader, plug the USB cable into the USB port of your PC or terminal. The USB reader will emulate a USB keyboard.

## 1.4 Pin Assignment

### 1. PC Keyboard Output

#### DIN 5 MALE

Pin No.	Function
1	HOST CLK
2	HOST DATA
4	GND
5	Vcc(+5V)

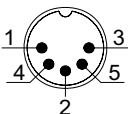

#### DIN 5 FEMALE

Pin No.	Function
1	KB CLK
2	KB DATA
4	GND
5	Vcc(+5V)

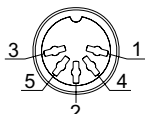

#### MiniDIN 6 MALE

Pin No.	Function
1	HOST DATA
3	GND
4	Vcc
5	HOST CLK

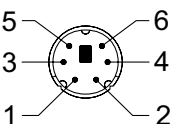

#### MiniDIN 6 FEMALE

Pin No.	Function
1	KB DATA
3	GND
4	Vcc
5	KB CLK

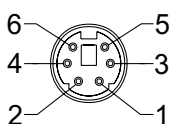

### 2. RS-232 Output

#### DB 9 Female

Pin No.	Function
2	TXD
3	RXD
5	GND
7	CTS
8	RTS
Power Lead	Vcc (+5V)

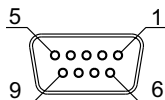

### 3. USB Interface

#### USB A Type Male

Pin No.	Function
1	Vcc
2	D-
3	D+
4	GND

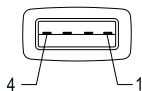

# Chapter 2 Configuration - General

## 2.1 Flow Chart

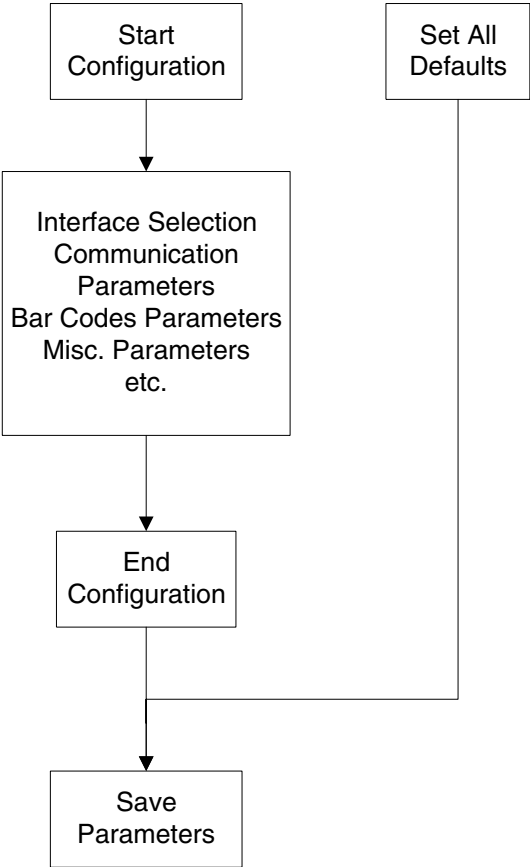

## 2.2 Loop of Programming

The philosophy of programming parameters has been shown on the flow chart of 2.1. Basically the user should

1. Scan Start of Configuration.
2. Scan all necessary labels for parameters that meet applications.
3. Scan End of Configuration to end programming.
4. Scan Save Parameters to permanently save the settings you programmed.
5. To go back to the Default Settings, just scan label for Set All Defaults.

## 2.3 Factory Default Settings

The factory default settings are shown with < > and bold in the following sections. You can make your own settings by following the procedures in this manual. If you want to save the settings permanently, you should scan the label of "Save Parameters" in chapter 2.4, otherwise the settings will not be saved after the decoder power is off, and all settings will go back to previous settings.

By scanning "Set All Default" label, the settings will go back to the factory default settings.

**Save Parameters**



**Set All Defaults**



**Start Configuration**



**End Configuration**



**Version Information**



## 2.5 Interface Selection

Keyboard Mode



**<RS232 Mode>**



USB Mode



# Ch.3 Communication Parameters

## 3.1 RS232 Mode Parameters

### A> Set Up BAUD Rate

2400



4800



<9600>



19200



### B> Set Up Data Bits

7 Data Bits



<8 Data Bits>



### C> Set Up Stop Bits

<1 Bit>



2 Bits



## D> Set Up Parity

<None>



%0DN7

Even



%0DN2

Odd



%0DN3

Mark



%0DN1

Space



%0DN0

## E> Handshaking

<RTS/CTS Disable>



%0E80

RTS/CTS Enable



%0E88

<ACK/NAK Disable>



%0EH0

ACK/NAK Enable



%0EH1

<XON/XOFF Disable>



%0EI 0

XON/XOFF Enable



%0EI 2

### 3.2 Keyboard Wedge Mode Parameters

#### A> Terminal Type

<IBM PC/AT, PS/2>



IBM PC/XT



Apple Desktop Bus(ADB)



NEC 9801



#### B> Upper/Lower Case

<Upper Case>



Lower Case



#### C> Send Character by ALT Method

<Disable>



Enable



## D> Select Numerical Pad

<OFF>



%0E00

ON



%0E08

### 3.3 Output Characters Parameters

#### A> Select Terminator

<CR+LF>



None



CR



LF



Space



HT(TAB)



STX-ETX



#### B> Time-out Between Characters

<0 ms>



15 ms



# Ch.4 Bar Codes and Others

## 4.1 Symboligies Selection

UPC-A <ON>



OFF



UPC-E <ON>



OFF



EAN-13/JAN-13 <ON>



OFF



EAN-8/JAN-8 <ON>



OFF



CODE 39 <ON>



OFF



CODE 128 <ON>



OFF



CODABAR/NW7 <ON>



OFF



Interleave 25 <ON>



OFF



## 4.2 UPC/EAN/JAN Parameters

### A> Reading Type

UPCA=EAN13 <OFF>



UPCA=EAN13 ON



ISBN/ISSN <Disable>



ISBN/ISSN Enable



<Not Transmit  
Supplementals>



Transmit  
Supplementals



### B> Check Digit Transmission

<Transmit Check Digit>



Not Transmit  
Check Digit



### 4.3 Code 39 Parameters

#### A> Reading Type

<Standard>



Full ASCII



#### B> Check Digit Transmission

<Do Not Calculate  
Check Digit>



Calculate Check Digit  
& Transmit



Calculate Check Digit  
& Not Transmit



#### C> Output Start/Stop Character

<Disable>



Enable



## 4.4 Code 128 Parameters

### A> Check Digit Transmission

Do Not Calculate  
Check Digit



Calculate Check  
Digit & Transmit



<Calculate Check Digit  
& Not Transmit>



# 4.5 CODABAR/NW7 Parameters

## A> Set Up Start/Stop Characters Upon Transmission

<OFF>



ON



## B> Transmission Type of Start/Stop

<A/B/C/D> <Start>



<A/B/C/D> <Stop>



A Start



A Stop



B Start



B Stop



C Start



C Stop



D Start



D Stop



## 4.6 Interleave 25 Parameters

### A> Check Digit Transmission

<Do Not Calculate  
Check Digit>



Calculate Check Digit  
& Transmit



Calculate Check Digit  
& Not Transmit



### B> 44+4 Function

<OFF>



ON



# Ch.5 Miscellaneous Parameters

## 5.1 Language Selection

<US English>



UK English



Italian



Spanish



French



German



Swedish



Switzerland



Hungarian



Japanese



Belgium



Portuguese



Demark



Netherlands



Turkey



Reserved1



## 5.2 Bar Code ID

<OFF>



ON



UPC-A Begin



UPC-E Begin



EAN-13 Begin



EAN-8 Begin



Code 39 Begin



Code 128 Begin



Codabar Begin



Interleave 25 Begin



## 5.3 Set Up Truncation

### A> Truncate Front Digit(s)

#### <Truncate Front 0 Digit>



#### Truncate Front 1 Digit



#### Truncate Front 2 Digits



#### Truncate Front 3 Digits



#### Truncate Front 4 Digits



#### Truncate Front 5 Digits



#### Truncate Front 6 Digits



#### Truncate Front 7 Digits



# B> Truncate End Digit(s)

## <Truncate End 0 Digit>



## Truncate End 1 Digit



## Truncate End 2 Digits



## Truncate End 3 Digits



## Truncate End 4 Digits



## Truncate End 5 Digits



## Truncate End 6 Digits



## Truncate End 7 Digits



## 5.4 Set Up Preamble and Postamble

### A> Set Up Preamble

<OFF>



1.Begin



2.ASCII Table  
(Appendix B)

3.Complete



There are 4 characters allowed to be added to the preamble. To set Preamble character(s):

1. Scan the "Start" label.
2. Scan "Begin" label above.
3. Go to ASCII Table in Appendix B, find the corresponding characters, scan the labels in Appendix B.
4. Back to the current page, scan the "Complete" label above.
5. Scan the "End" label.

## B> Set Up Postamble

<OFF>



1.Begin



2.ASCII Table  
(Appendix B)

3.Complete



There are 4 characters allowed to be added to the postamble. To set Postamble character(s):

1. Scan the "Start" label.
2. Scan "Begin" label above.
3. Go to ASCII Table in Appendix B, find the corresponding characters, scan the labels in Appendix B.
4. Back to the current page, scan the "Complete" label above.
5. Scan the "End" label.



SPACE



#



&



)



,



/



2



5



8



;



>



"



%



(



+



.



1



4



7



:



=



!



\$



,



\*



-



0



3



6



9



<



?



@



40

C



43

F



46

I



49

L



4C

O



4F

R



52

U



55

X



58

[



5B

^



5E

B



42

E



45

H



48

K



4B

N



4E

Q



51

T



54

W



57

Z



5A

]



5D

A



41

D



44

G



47

J



4A

M



4D

P



50

S



53

V



56

Y



59

\



5C

\_



5F

,



60

c



63

f



66

i



69

l



6C

o



6F

r



72

u



75

x



78

{



7B

~



7E

b



62

e



65

h



68

k



6B

n



6E

q



71

t



74

w



77

z



7A

}



7D

a



61

d



64

g



67

j



6A

m



6D

p



70

s



73

v



76

y



79

|



7C

DEL



7F

**Save Parameters**



**Set All Defaults**



**Start Configuration**



**End Configuration**



**Version Information**

